



IDP-3050-A
 version 2
8 Outlet Power Strip
with Personal Sensor



Installation Instructions

SPECIFICATIONS

UL & cUL listed

Power Strip

Electrical rating	125VAC, 12A, 50/60Hz
Dry contact relay	12A
Grounded LED	indicates correct wiring and grounding
Protected LED	indicates functioning of surge protection
Eight outlets	six controlled, two uncontrolled
8 foot cord	black
UL 1449 rating	400V
Circuit	High Energy, Multi-stage hybrid
Noise filtration	0-25dB (94.38%)
Joule rating	740 Joules
Maximum surge amperage	48,000 Amps
Protection modes	L-N, L-G, N-G
Response time	instantaneous
Let through voltage	140V
Initial clamping voltage	200V
Personal Sensor	DI-110 passive infrared occupancy sensor
Supply Voltage	12VDC Typical
Time Delay Adjustment	30 seconds to 30 minutes



US Patents:
 4,787,722
 5,455,487
 5,598,042



Santa Clara, CA 95050

DESCRIPTION

The Watt Stopper Isolé IDP-3050-A is an advanced energy saving control system, designed for general office use. It combines an eight-outlet power strip with the DI-110 personal sensor. The IDP-3050-A controls power used by plug load devices, and provides surge protection. Its use reduces energy costs and helps the environment by turning power-consuming devices off based on occupancy.

THE POWER STRIP

Functionally, the power strip provides surge protection. It also filters noise caused by electromagnetic interference (EMI) and radio frequency interference (RFI).

Outlets

Six of the power strip's eight outlets are controlled by the personal sensor and the remaining two are uncontrolled.

Switches

The power strip has an ON/OFF switch to turn on or off its outlets.

CAUTION: RISK OF ELECTRIC SHOCK. DO NOT PLUG INTO ANOTHER RELOCATABLE POWER TAP. This device features an internal protection that will disconnect the surge protective component at the end of its useful life but will maintain power to the load now unprotected.

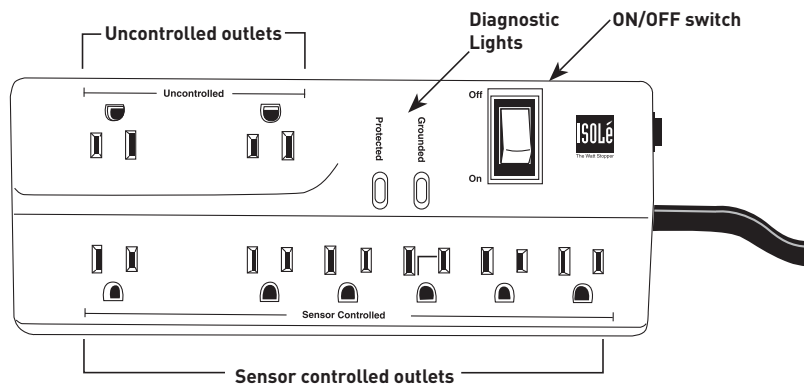

Call 800.879.8585 for Technical Support

Diagnostic Lights

“Protected” LED indicator: When the surge protector is operating correctly, the LED indicator labeled “Protected” is lit. When unlit, this LED indicates the occurrence of a power disturbance or fault within the unit.

WARNING
When the surge protector fails (LED unlit) power to the Sensor Controlled outlets is disabled. The Uncontrolled outlets maintain power but the loads connected to them are unprotected.

“Grounded” LED indicator: Another LED indicator, labeled “Grounded,” is lit when the wall outlet is properly wired and grounded. The surge protection will not operate if the power strip is not properly grounded.

THE DI-110 PERSONAL SENSOR

The DI-110 personal sensor uses passive infrared technology to detect occupancy within a workspace. When the sensor detects occupancy, it automatically turns on the power strip’s six controlled outlets. It turns off these outlets when the workspace becomes unoccupied and the user-set time delay elapses. (See “Time Delay Setting.”) Uncontrolled outlets are continuously powered by the power strip and remain on regardless of occupancy.

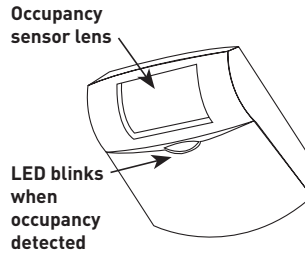

Personal Sensor Placement

The sensor uses a multi-segmented Fresnel lens to view a coverage area. Position the sensor to have a clear view of motion (especially hand motion) in the workspace. Make sure that it does not view open doors or entrances where people passing by may be detected.

The diagrams below show the sensor’s coverage pattern. They illustrate the areas where the sensor will best sense motion. Use the diagrams as a general reference to determine the position and orientation of the sensor.

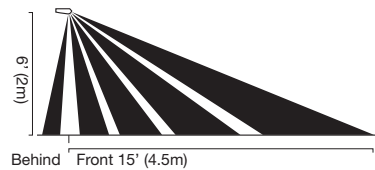

Side view

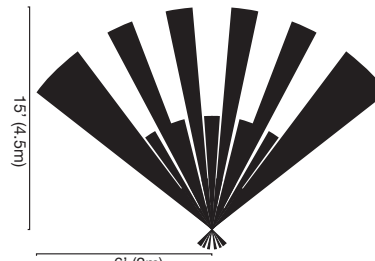

Overhead view

DI-110 Office Placement Examples

These diagrams give examples of sensor placement in a workspace while illustrating typical coverage patterns and coverage ranges.

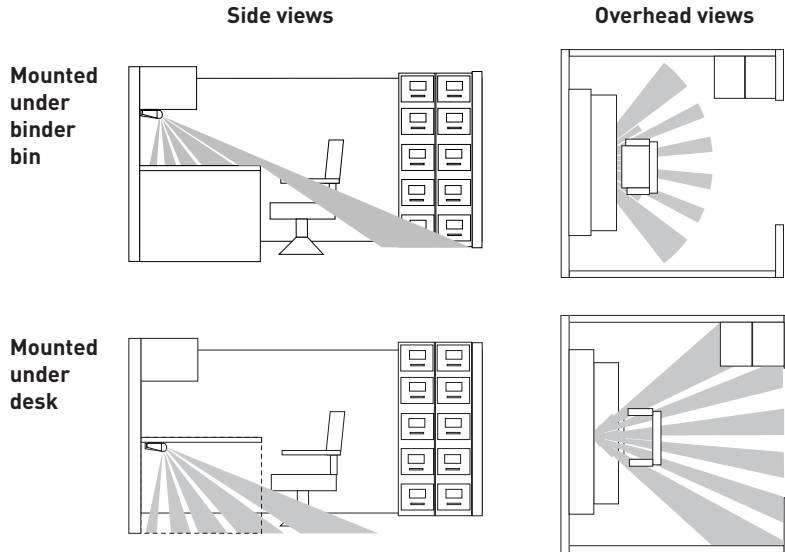

Altering Coverage Ranges

The IDP-3050-A package also includes strips of tape, used to mask areas of the sensor lens. Masking the lens allows the user to alter or refine coverage areas.

To narrow coverage, place tape on left or right sides of the lens. To shorten coverage, place tape on the top or bottom of the lens. See the illustrations here as examples.

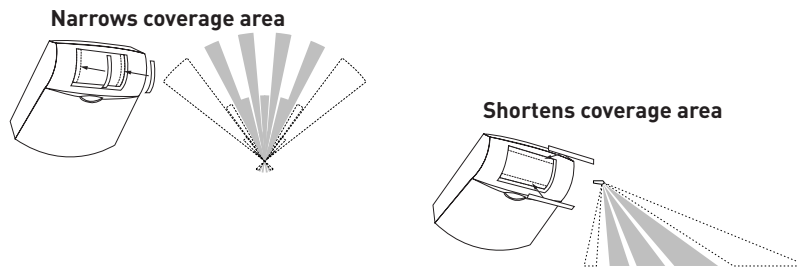

Call 800.879.8585 for Technical Support

PERSONAL SENSOR MOUNTING

Note: When determining mounting locations, verify that the connecting cable from the personal sensor will comfortably reach the cable socket on the power strip.

The DI-110 is usually mounted under a desk or binder bin as shown in the office placement example diagrams. However, it can be mounted to any flat surface.

1. Attach the mounting plate to the desired location with the provided self-tapping screw or double-backed tape.
2. Snap the sensor onto the mounting plate.

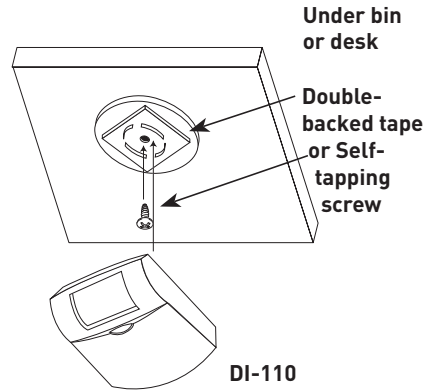

INSTALLATION

DI-110 Personal Sensor

- Plug one end of the provided cable into the back of the DI-110 and the other end of the cable into the side of the power strip.

CAUTIONS

Follow local building and safety codes when installing this product. Plug only the Isolé personal sensor into the power strip's jack—otherwise, damage may result. Never plug any devices that must remain on throughout the day (e.g., cpu) into the controlled outlets.

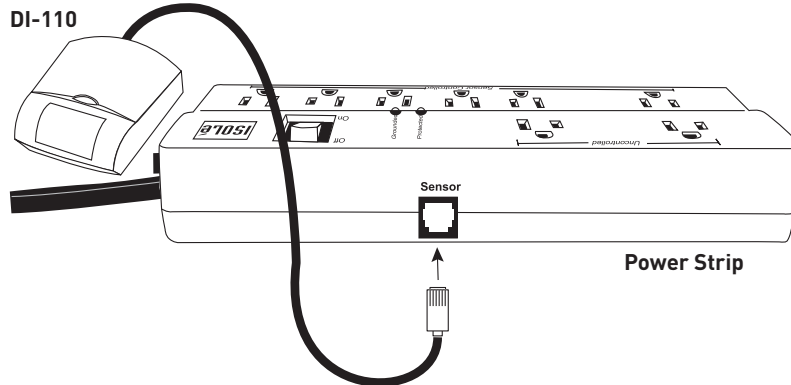

Power Strip

- Plug the power cord into a 120VAC wall receptacle.

Call 800.879.8585 for Technical Support

Time Delay Setting

The personal sensor automatically turns off all controlled devices after a workspace becomes vacant and a pre-set time interval, or time delay, elapses. This setting is user-adjustable.

Turning the trimpot dial, located on the back on the sensor, clockwise or counterclockwise adjusts the time delay. The range for adjustment is 30 seconds to 30 minutes.

- To adjust to 30 seconds (minimum), turn the dial completely counterclockwise.
- To adjust to 30 minutes (maximum), turn the dial completely clockwise.
- To adjust to 15 minutes, turn the dial half way between its maximal clockwise and counterclockwise positions.

Note: Use a small screwdriver to make adjustments.

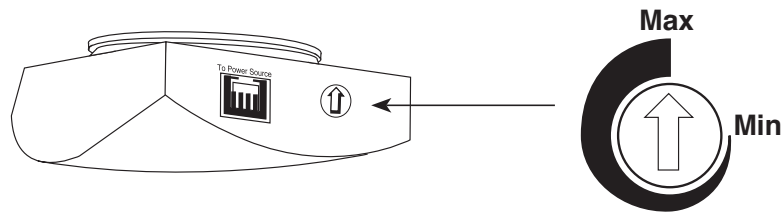

Initial Warm-up

The personal sensor requires an initial warm-up period of up to two minutes whenever the power strip is turned on. During this time, all connected devices will remain on, regardless of occupancy or the time delay setting.

TROUBLESHOOTING

Devices do not turn on with occupancy. If the LED, labeled “Grounded,” is not lit:

- Make certain that the power strip is securely plugged into a properly grounded and wired outlet. Check that the ON/OFF switch is in the “ON” position.
- Make certain that the cable connection between the personal sensor and the power strip is secure.
- Make certain that the personal sensor is positioned to view the desired coverage area. (See “Personal Sensor Placement.”)

Devices turn on without occupancy.

The sensor may be detecting people outside of the workspace.

- Reorient the sensor so that it does not view beyond the boundaries of the workspace.

The controlled devices turn off when the workspace is occupied.

- Change the personal sensor’s location or orientation within the workspace to increase the sensor’s detection of motion, especially hand motion. (See “Personal Sensor Placement.”)
- Increase the personal sensor’s time delay setting. (See “Time Delay Setting.”)

The Protected LED is not lit.

- Turn the power strip off and then on. If the Protected LED remains off, the surge suppression feature has stopped working. Devices requiring surge protection should not be plugged into the power strip’s outlets when the Protected LED is unlit. The power strip may need to be replaced. Call Technical Support.

The Grounded LED is not lit.

- Electrical outlet may not be functioning properly. Switch to a properly grounded electrical outlet. Report to facility manager or engineer for verification and repair.

These suggestions should help solve most problems. For further assistance, call Technical Support at 800.879.8585.

Call 800.879.8585 for Technical Support

ORDERING INFORMATION

Catalog#	Description
IDP-3050-A	Eight outlet Power Strip with DI-110 Personal Sensor

WARRANTY INFORMATION

Watt Stopper/Legrand warranties its products to be free of defects in materials and workmanship for a period of five (5) years. There are no obligations or liabilities on the part of Watt Stopper/Legrand for consequential damages arising out of, or in connection with, the use or performance of this product or other indirect damages with respect to loss of property, revenue or profit, or cost of removal, installation or reinstallation.



2800 De La Cruz Boulevard, Santa Clara, CA 95050
Technical Support: 800.879.8585
www.wattstopper.com
08955r2 01/2008

Please
Recycle

